

W-35-3

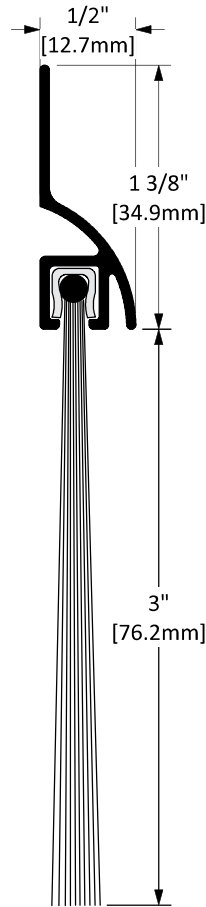

Intertek



Finish Options

STD Clear Anodized

Screw Options

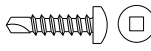
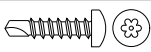
- | | |
|-----------------|--|
| STANDARD | 
SCREW TYPE: A
#8 X 3/4" STAINLESS STEEL PAN HEAD, ROBERTSON DRIVE, TEK SCREWS |
| | 
SCREW TYPE: B
#8 X 3/4" STAINLESS STEEL PAN HEAD, TAMPER-RESISTANT TORX DRIVE, TEK SCREWS |

Operation	Door Sweep with Drip Cap
Features	<ul style="list-style-type: none"> • Clear Anodized Extruded Aluminum with 3" Nylon Brush
Application	<ul style="list-style-type: none"> • Ideal for Residential, Commercial & Industrial

Part No.: _____ **Part Description:** _____

Customer Name: _____ **Job No./Name:** _____ **Date:** _____ **Provided By:** _____

Notes: