

C-911

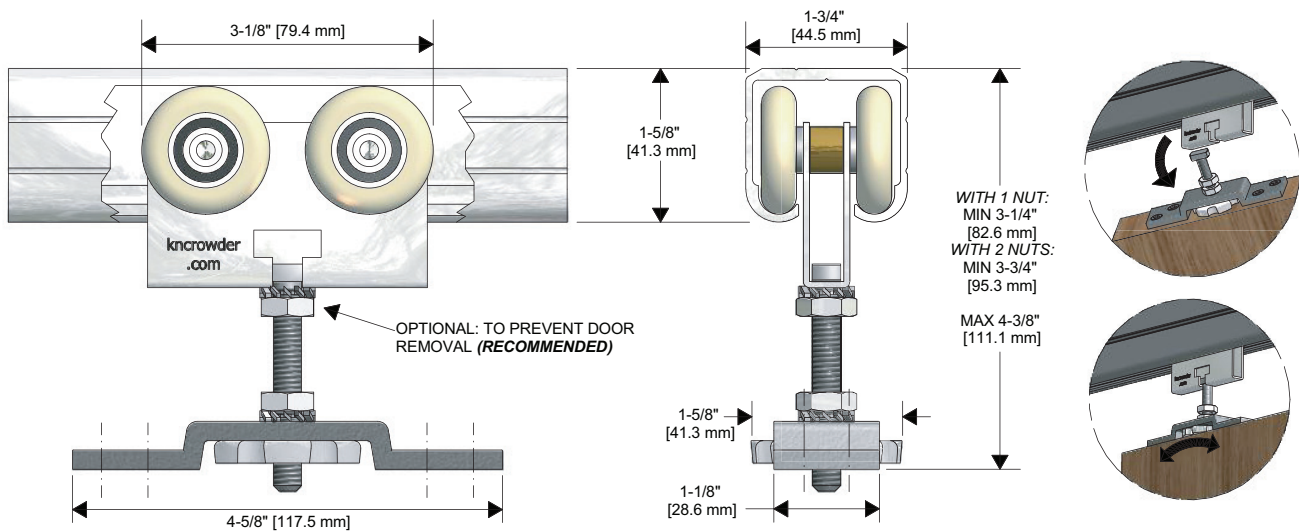

KEY FEATURES:

- Top mount Quick Release “Spinwheel” hanger (**C-911**)
- Hanger with quick release feature for fast and easy door removal, and easy installation.
- For Single, Bi-parting, By-Passing, Pocket or Wall Mounted doors.
- Four Precision Ground Ball Bearing, Nylon Tire Wheels.
- Reduces installation time allowing one person to install.
- Use with Extruded Aluminum **C-104** Track, 6063T5 Alloy
- Load Capacity **200lbs. (two hangers)**



Part Number:	Part Description:		
Customer Name:	Job Number/Name:	Date:	Provided By:
Notes:			