



K.N. CROWDER MFG. INC.
 1220 BURLOAK DRIVE
 BURLINGTON, ONTARIO
 L7L 6B3 CANADA

K.N. CROWDER. INC.
 210 EIGHTH STREET SOUTH
 LEWISTON, NEW YORK
 14092 U.S.A.

TOLL-FREE PHONE: 1-866-999-1KNC (1562)
 WEBSITE: kncrowder.com
 EMAIL: customerservice@kncrowder.com

CT-65SS



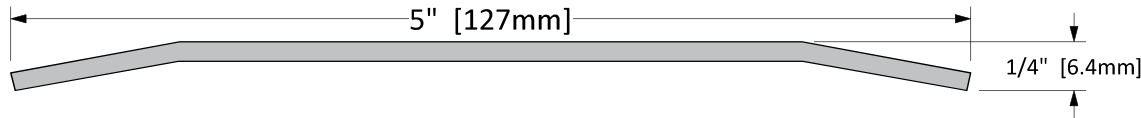

Finish Options

STD 11 GA. 304 Stainless Steel 2B



Screw Options

STANDARD	 SCREW TYPE: H #10 X 1-3/4" STAINLESS STEEL FLAT HEAD, ROBERTSON DRIVE, TYPE A SCREWS (COMPLETE WITH NYLON ANCHOR)
	 SCREW TYPE: I #10 X 2" STAINLESS STEEL FLAT HEAD, TAMPER-RESISTANT TORX DRIVE, TYPE A SCREWS (COMPLETE WITH NYLON ANCHOR)

Operation	Threshold
Features	<ul style="list-style-type: none"> Stainless Steel
Application	<ul style="list-style-type: none"> Ideal for Residential, Commercial & Industrial

Part No.: **Part Description:**

Customer Name: **Job No./Name:** **Date:** **Provided By:**

Notes: