

# CATCH'N'CLOSE CROWDERFRAME POCKET DOOR KIT

## INTRODUCING THE TYPE CC SERIES

### Catch'N'Close Crowderframe Pocket Door Kit

Catch'N'Close Crowderframe Pocket Door Kits are the answer where space is limited or where the swinging of a hinged door is undesirable or inconvenient. Enjoy the benefits of hiding the door in a wall for a clean and spacious look! It can be installed in single door or double bi-parting door applications.

#### Key Product Features:

- Complete with roll formed steel uprights for less deflection and easy to screw into for drywall fastening
- Provides easier and quicker installation than a traditional pocket built on site
- Integrating the revolutionary Catch'N'Close system prevents bouncing and slamming of the sliding doors and can be installed on both the opening and closing ends of the door
- For Standard 2X4 Wall Construction

### HOW IT ALL COMES TOGETHER (TYPE CC-1W Catch'N'Close Crowderframe Pocket Door Kit Shown)

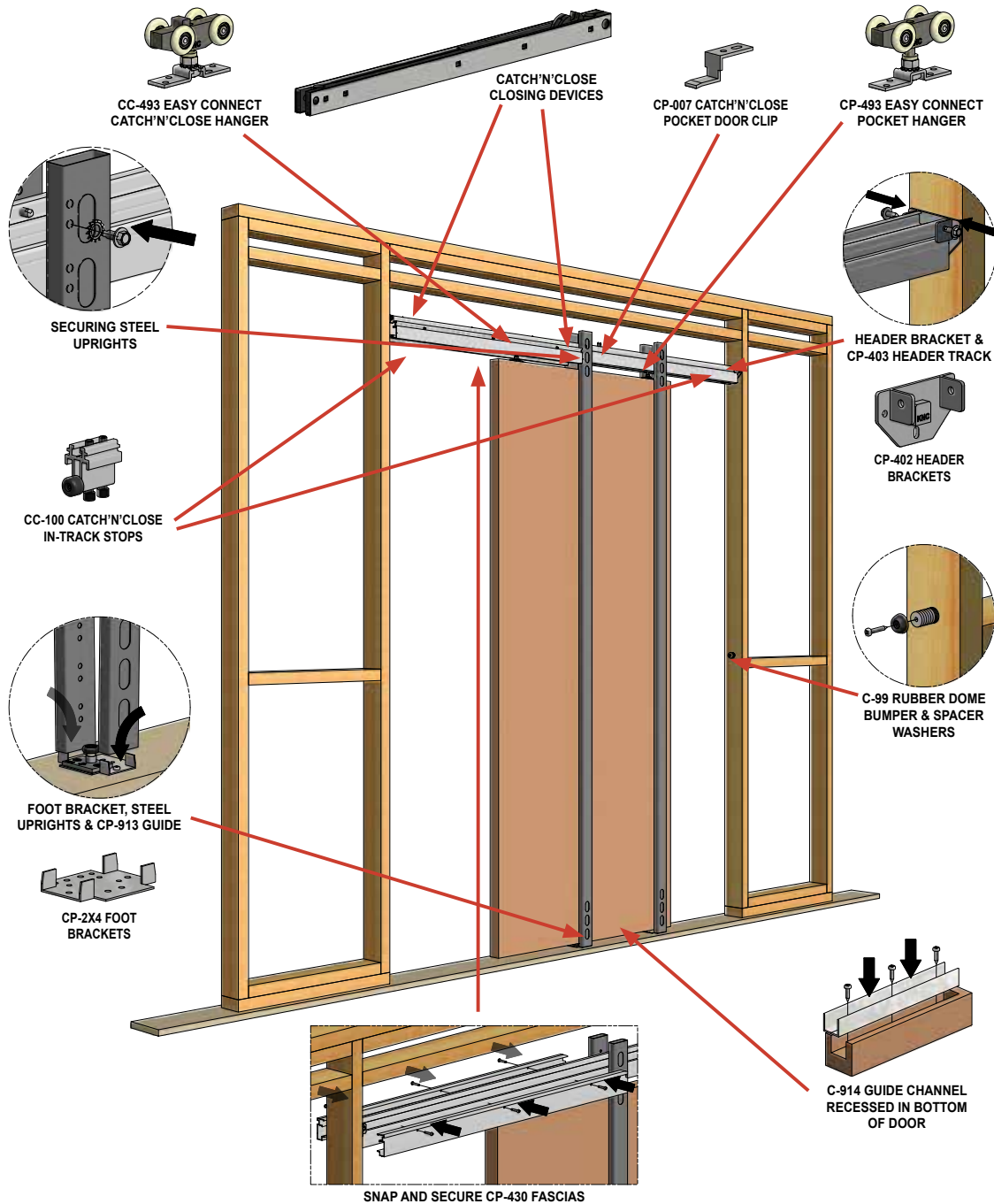

A PRODUCT OF K.N. CROWDER MFG. INC.

TOLL-FREE PHONE: 1-866-999-1KNC (1562) • WEBSITE: [www.kncrowder.com](http://www.kncrowder.com) • EMAIL: [customerservice@kncrowder.com](mailto:customerservice@kncrowder.com)

© 2016 K.N. CROWDER MFG. INC. All Rights Reserved.

# CATCH'N'CLOSE CROWDERFRAME POCKET DOOR KIT



## TYPE CC-W

### CC-493 Easy Connect Catch'N'Close Hanger

#### Key Product Features:

- Complete with roll formed steel uprights for less deflection and easy to screw into for drywall fastening
- Provides easier and quicker installation than a traditional pocket built on site
- Integrating the revolutionary Catch'N'Close system prevents bouncing and slamming of the sliding doors and can be installed on both the opening and closing ends of the door
- For Standard 2X4 Wall Construction
- Nylon Wheels with Precision Ground Ball Bearings
- Proudly North American made
- **CC-493** Easy Connect Catch'N'Close Hanger Load Capacity **150 lbs. (two Hangers)**
- **CP-403** Extruded Aluminum Header Track, 6061-T5 Alloy
- **Includes:**

**CATCH'N'CLOSE™**  
Closes safely and silently



**1 3/4 in**  
**[44.5 mm]**  
OR  
**1 3/8 in**  
**[34.9 mm]**

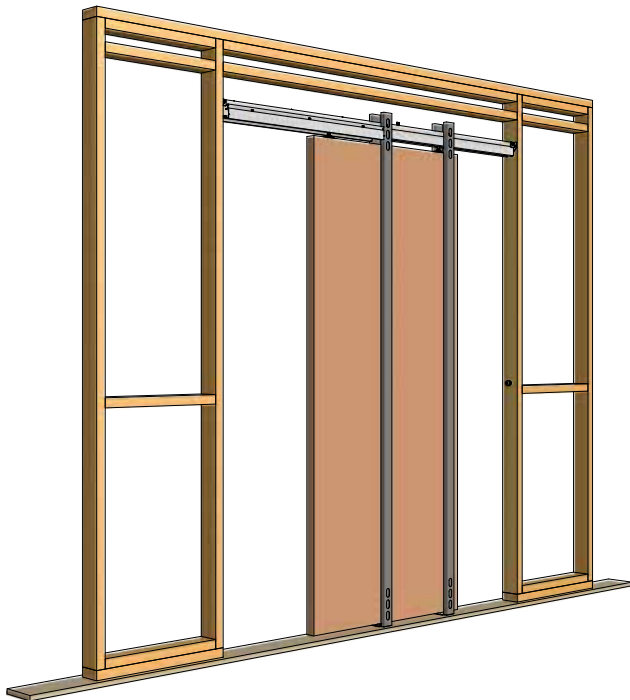

## HOW TO SPECIFY/ORDER TYPE CC-1W FOR ONE DOOR OPENING

### KIT CODE:

### TYPE CC-1W CATCH'N'CLOSE CROWDERFRAME POCKET DOOR KIT

Suitable for one door from: 26 in [660 mm] to 36 in [914 mm] wide x 80 in [2032 mm] to 84 in [2134 mm] or 2150 mm high

For other door sizes or custom applications, please contact customer service.

For doors weighing 75lbs or less, please use the CC-75 Catch'N'Close Closing Device, specify/order as TYPE CC-75W

(All Catch'N'Close Crowderframe Pocket Door Kits above are complete with all hardware for one complete opening. Wood framing and door are by others. For locks and pulls please visit our website for more details)

## HOW TO SPECIFY/ORDER ADD-ON PRODUCTS FOR ABOVE KITS

- For **Double Bi-Parting Door applications**, please review and specify **CPD-CC-JOINER** kit as an add-on in addition to two (2) single Catch'N'Close Crowderframe Pocket Door Kits as shown above based on door sizes.

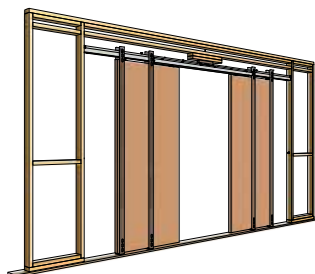
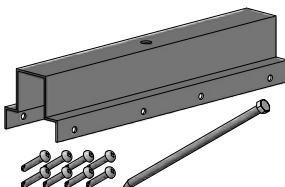

- For **2X6 Wall Construction applications**, please review and specify **CP-CC-2X6 SHIM** kit as an add-on in addition to each single Catch'N'Close Crowderframe Pocket Door Kits as shown above based on door sizes. (Two (2) shim kits are required for double bi-parting door applications using the CPD-CC-JOINER Kit)

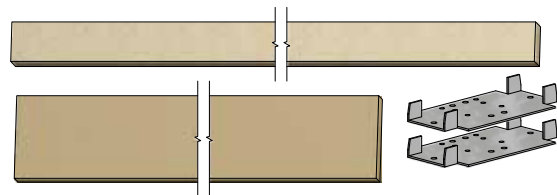

# CATCH'N'CLOSE CROWDERFRAME POCKET DOOR KIT

## TYPE CC-W CATCH'N'CLOSE CROWDERFRAME POCKET DOOR KIT DIMENSION DETAILS (WITH C-914/CP-913 GUIDE SYSTEM)

ARCHITECTURE & DESIGN  
COLLECTION

INCLUDES  
CATCH'N'CLOSE

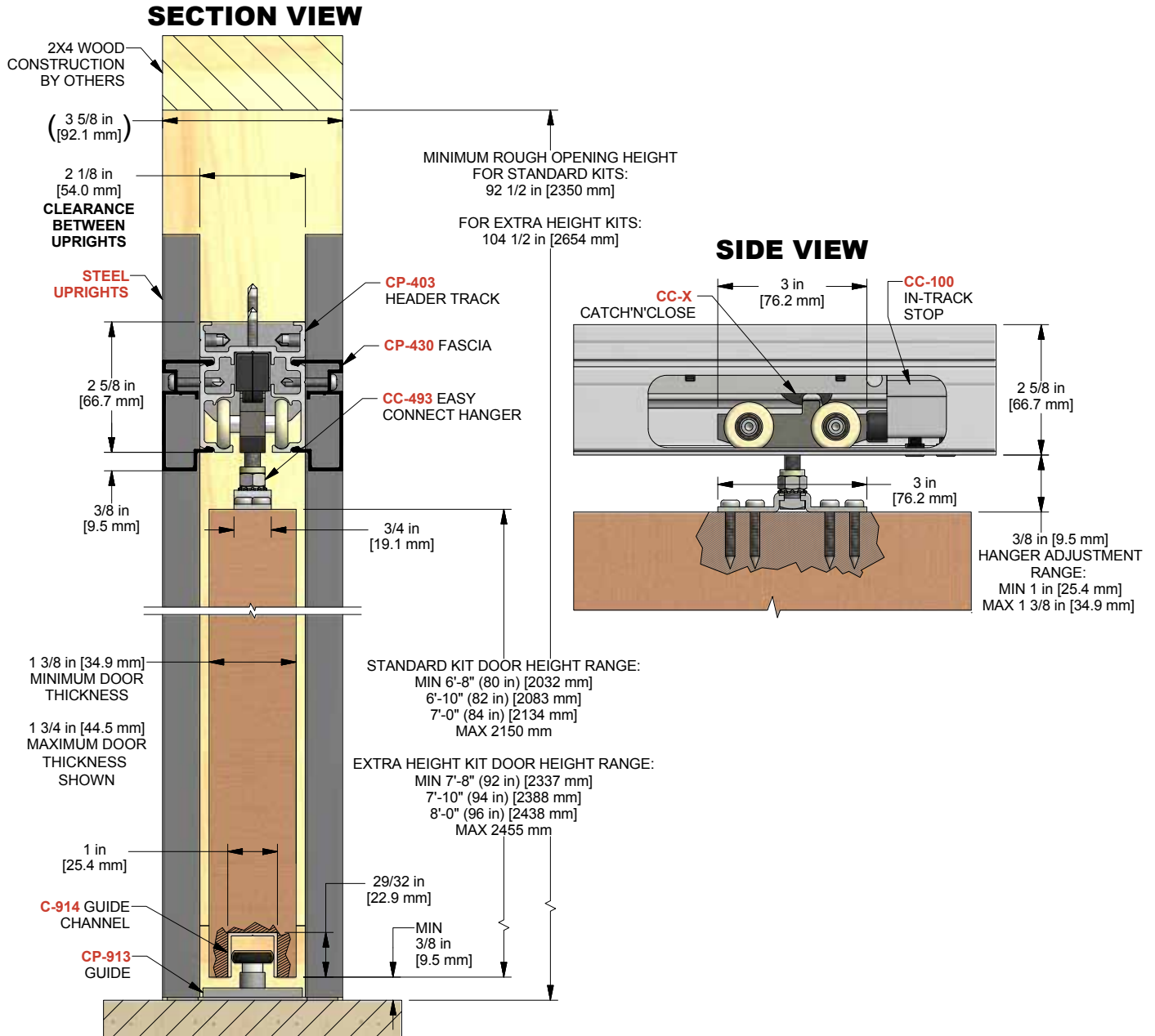

### ELEVATION VIEW OF COMPLETE INSTALLATION (FOR DOORS 26 in [660 mm] TO 48 in [1219 mm] WIDE)

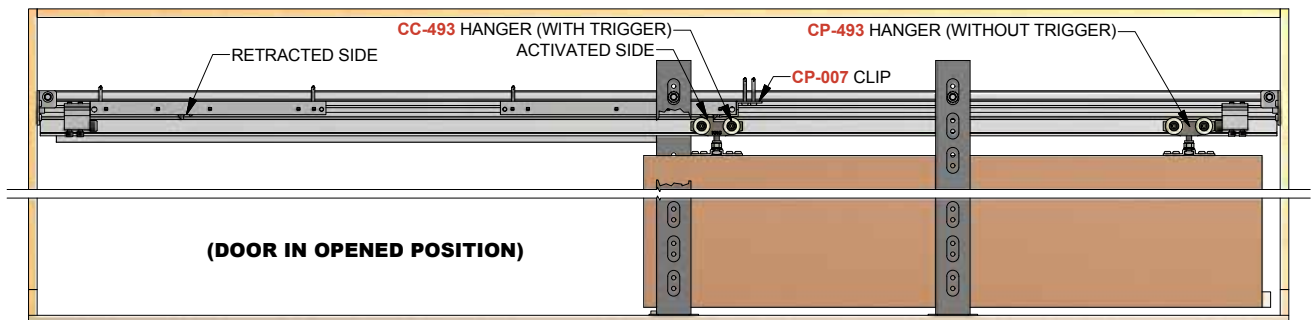

A PRODUCT OF K.N. CROWDER MFG. INC.

TOLL-FREE PHONE: 1-866-999-1KNC (1562) • WEBSITE: www.kncrowder.com • EMAIL: customerservice@kncrowder.com

© 2016 K.N. CROWDER MFG. INC. All Rights Reserved.