

CROWDER STRIKE



FEATURES

- Created to be paired with CCSF-998 Catch 'N' Close series for doors up to 300 lbs. [136 kg]
- Continuous full height strike kit provides a clean look using aluminum snap-on covers
- Ideal for medical, office and hospitality applications
- Available in clear or black anodized, mill finish or powder coated

Each kit includes: continuous wall strike base x length based on kit size, wall strike cover plate x length based on kit size c/w necessary fasteners. Clear anodized finish.

Note: Strike prep is not included. Available as a separate custom upcharge.

Handing

- Left hand
- Right hand



Handing Chart

Door Thickness

- 1-3/4 in [44.5 mm]
- 1-3/8 in [34.9 mm]

Door Height

- 2150 mm high [84 in or 84.625 in]
- 96 in [2438 mm]
- 120 in [3048 mm]

OPTIONAL

Door Locks and Pulls



Strike Plate and Dust Proof Box Prep

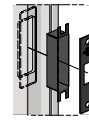

Left

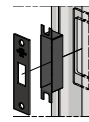

Right



Customer Name

Job No./Name

Date

Provided By

Notes

CROWDER STRIKE



COMPLETE PLAN VIEW

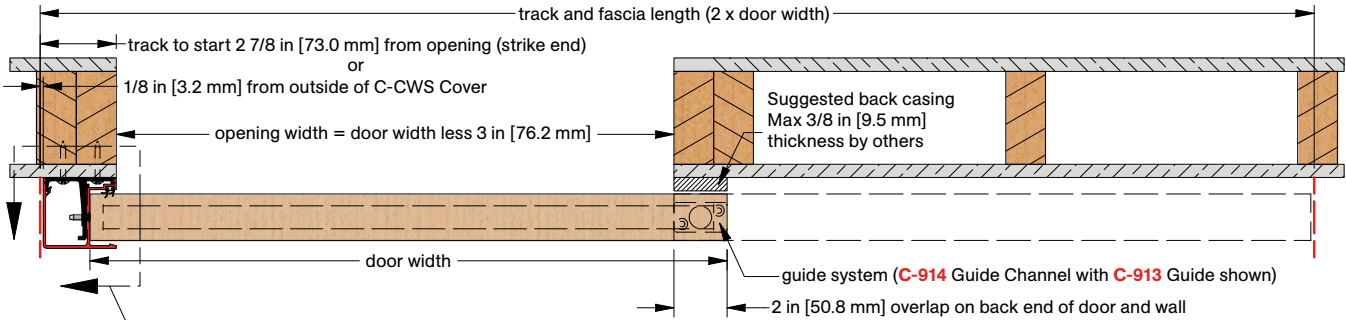

SECTION VIEW - CCSF-998

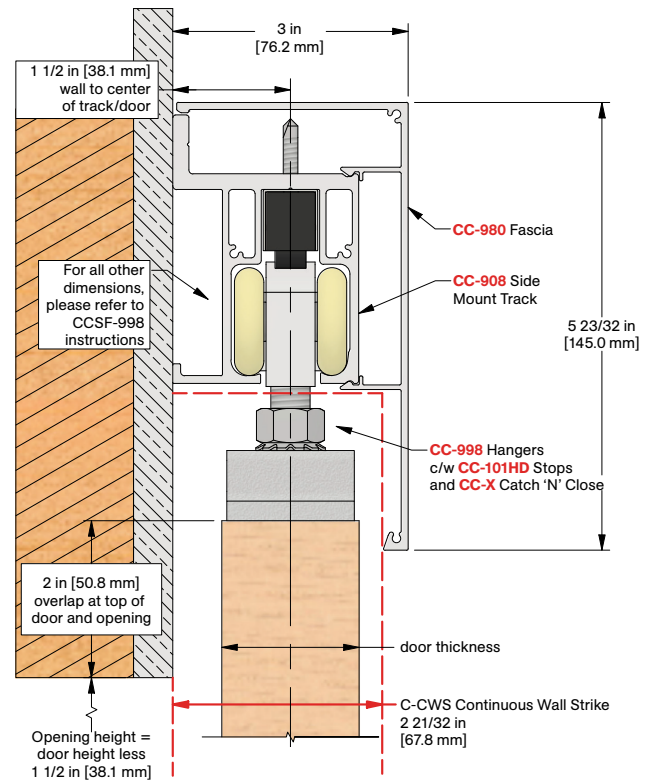
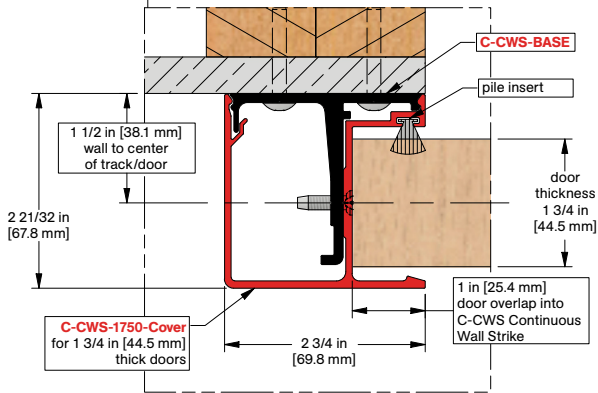

Installation
Instructions



Customer Name

Job No./Name

Date

Provided By

Notes