

CGP-038 GLASS DOOR EDGE PULL

PRODUCT DETAIL & INSTALLATION TEMPLATE

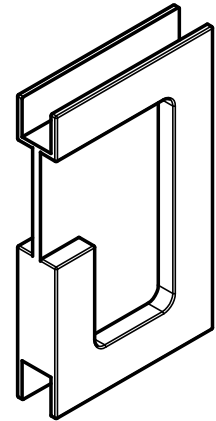
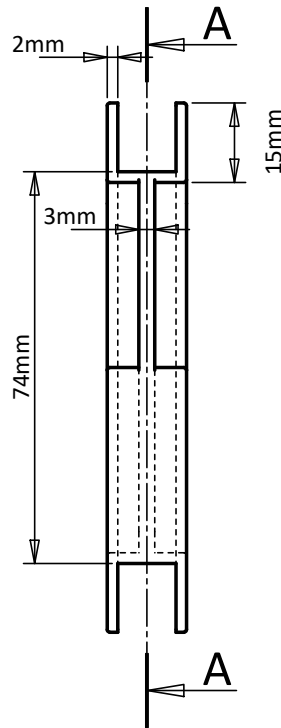
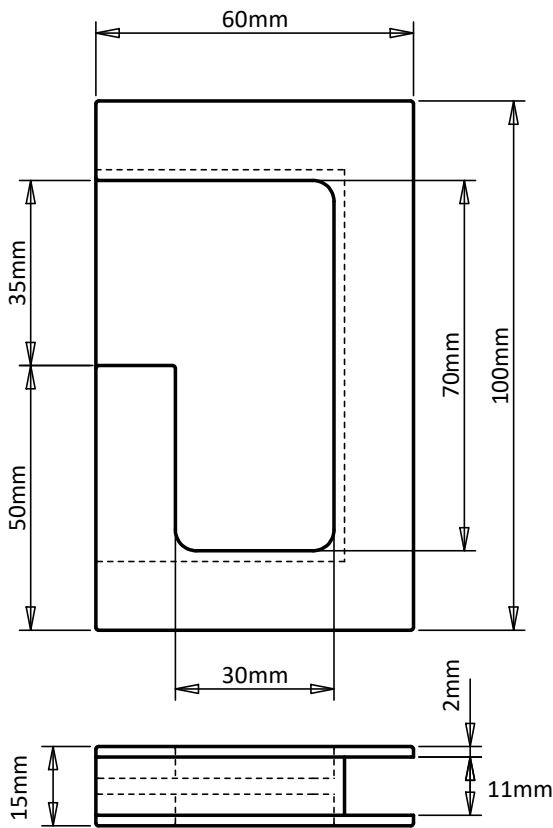

INSTALLATION:

1. Cut glass as per the glass prep below.
2. Fill space between cut line and cross-hatched area with clear epoxy adhesive such as WEICON Easy Mix N-5000 and let dry and harden properly before use.

GLASS PREP WITH 10mm RADIUS CUT 80mm X 50mm

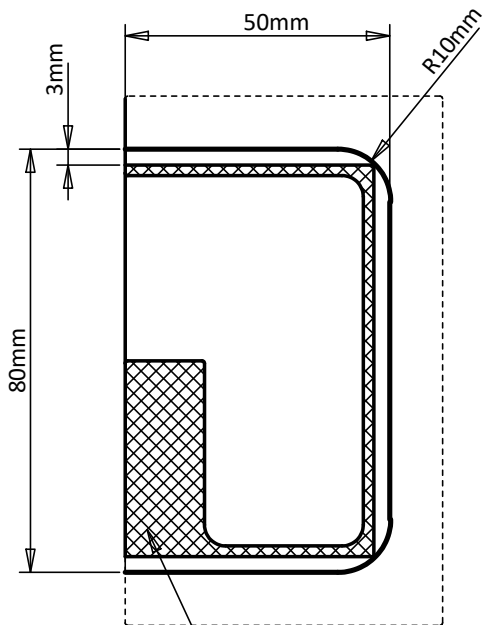

The cross hatched area is the cut A-A

GLASS PREP WITH 20mm RADIUS CUT 86mm X 53mm

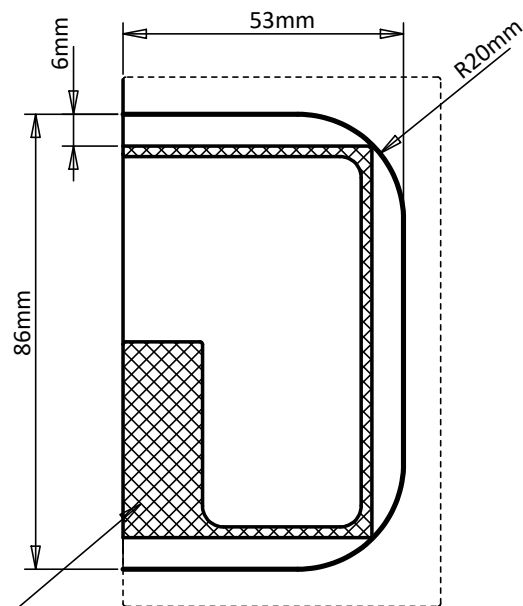

NOTE: template is not to scale



K.N. CROWDER MFG. INC.

1220 BURLOAK DRIVE
BURLINGTON, ONTARIO, CANADA, L7L 6B3
TOLL-FREE PHONE: 1-866-999-1KNC (1562)
TOLL-FREE FAX: 1-800-567-0123

WEBSITE: www.kncrowder.com --- EMAIL: customerservice@kncrowder.com

K.N. CROWDER INC.

210 EIGHTH STREET SOUTH
LEWISTON, NEW YORK, U.S.A. 14092
TOLL-FREE PHONE: 1-866-999-1KNC (1562)
TOLL-FREE FAX: 1-800-567-0123

© 2018 K.N. CROWDER MFG. INC. All Rights Reserved.