

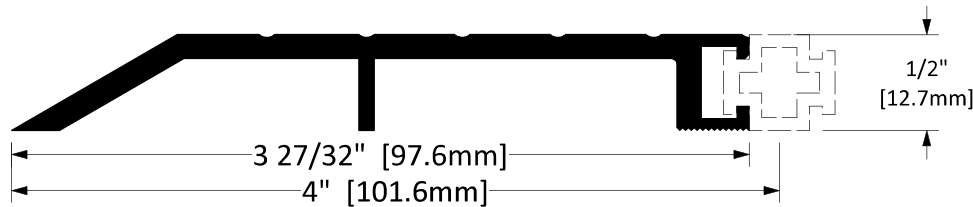



CT-42-1



Finish Options

OPTIONAL	STD	Mill Finish
		Bronze Anodized
		Black Anodized
		Clear Anodized

Screw Options

STANDARD		SCREW TYPE: G 3/16" X 1-3/4" HI-LO TAPPING THREAD, GREY PHILLIPS DRIVE, CONCRETE SCREWS (5/32" PRE-DRILL REQUIRED)
		SCREW TYPE: H #10 X 1-3/4" STAINLESS STEEL FLAT HEAD, ROBERTSON DRIVE, TYPE A SCREWS (COMPLETE WITH NYLON ANCHOR)
		SCREW TYPE: I #10 X 2" STAINLESS STEEL FLAT HEAD, TAMPER-RESISTANT TORX DRIVE, TYPE A SCREWS (COMPLETE WITH NYLON ANCHOR)

Operation	Thermal Break Threshold
Features	<ul style="list-style-type: none"> • Mill Finish Extruded Aluminum • Insert not included
Application	<ul style="list-style-type: none"> • Ideal for Residential, Commercial & Industrial

Part No.: _____ **Part Description:** _____

Customer Name: _____ **Job No./Name:** _____ **Date:** _____ **Provided By:** _____

Notes: