



**K.N. CROWDER MFG. INC.**  
 1220 BURLOAK DRIVE  
 BURLINGTON, ONTARIO  
 L7L 6B3 CANADA

**K.N. CROWDER. INC.**  
 210 EIGHTH STREET SOUTH  
 LEWISTON, NEW YORK  
 14092 U.S.A.

TOLL-FREE PHONE: 1-866-999-1KNC (1562)  
 WEBSITE: kncrowder.com  
 EMAIL: customerservice@kncrowder.com

# CT-66SS



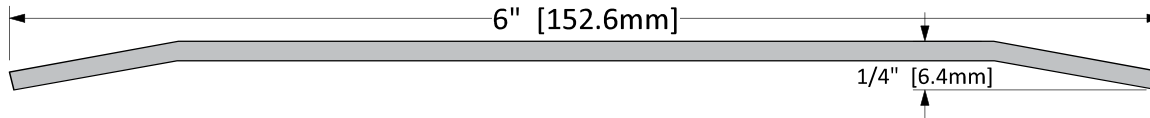

## Finish Options

**STD** 11 GA. 304 Stainless Steel 2B



## Screw Options

<b>STANDARD</b>	 SCREW TYPE: <b>H</b> #10 X 1-3/4" STAINLESS STEEL FLAT HEAD, ROBERTSON DRIVE, TYPE A SCREWS (COMPLETE WITH NYLON ANCHOR)
	 SCREW TYPE: <b>I</b> #10 X 2" STAINLESS STEEL FLAT HEAD, TAMPER-RESISTANT TORX DRIVE, TYPE A SCREWS (COMPLETE WITH NYLON ANCHOR)

<b>Operation</b>	Threshold
<b>Features</b>	<ul style="list-style-type: none"> <li>Stainless Steel</li> </ul>
<b>Application</b>	<ul style="list-style-type: none"> <li>Ideal for Residential, Commercial &amp; Industrial</li> </ul>

**Part No.:**                      **Part Description:**

**Customer Name:**              **Job No./Name:**                      **Date:**                      **Provided By:**

**Notes:**