

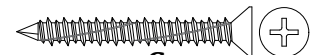

CT-813

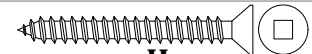
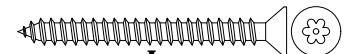

Screw Options

STANDARD	 SCREW TYPE: G 3/16" X 1-3/4" HI-LO TAPPING THREAD, GREY PHILLIPS DRIVE, CONCRETE SCREWS (5/32" PRE-DRILL REQUIRED)
	 SCREW TYPE: H #10 X 1-3/4" STAINLESS STEEL FLAT HEAD, ROBERTSON DRIVE, TYPE A SCREWS (COMPLETE WITH NYLON ANCHOR)
OPTIONAL	 SCREW TYPE: I #10 X 2" STAINLESS STEEL FLAT HEAD, TAMPER-RESISTANT TORX DRIVE, TYPE A SCREWS (COMPLETE WITH NYLON ANCHOR)

Finish Options

STD Mill Finish

Operation	Threshold
Features	<ul style="list-style-type: none"> Mill Finish Extruded Aluminum
Application	<ul style="list-style-type: none"> Ideal for Residential, Commercial & Industrial

Part No.: _____ **Part Description:** _____

Customer Name: _____ **Job No./Name:** _____ **Date:** _____ **Provided By:** _____

Notes: _____