

C-107-4 HANGER FOR C-104 OR C-108 TRACK INSTRUCTION SHEET

PARTS LIST

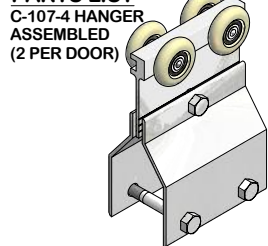

5/16"-18 X 2-1/2" HEX BOLT (2 PER HANGER)



5/16" PLAIN WASHER (2 PER HANGER)



5/16" HEX NUT (2 PER HANGER)



EXTRUDED ALUMINUM TRACK

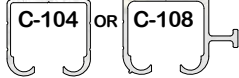

OR C-107-8 HANGER ASSEMBLED 7" WIDE (2 PER DOOR)

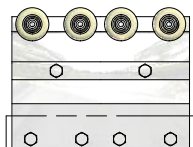

C-107-8 DETAIL "A"

SPECIFICATIONS:
-LOAD CAPACITY:
C-107-4 HANGERS:
350 LBS PER DOOR
C-107-8 HANGERS:
600 LBS PER DOOR

-HEAVY-DUTY PRECISION BALL BEARING WHEELS WITH NYLON TIRE.

-CLAMP-TYPE FACE MOUNTING DESIGN. ADJUSTABLE FOR DOOR THICKNESS OF 1-3/4" - 2-1/4".

-FOR BY-PASSING, BI-PARTING, POCKET, AND SURFACE MOUNT/BARN STYLE APPLICATIONS.

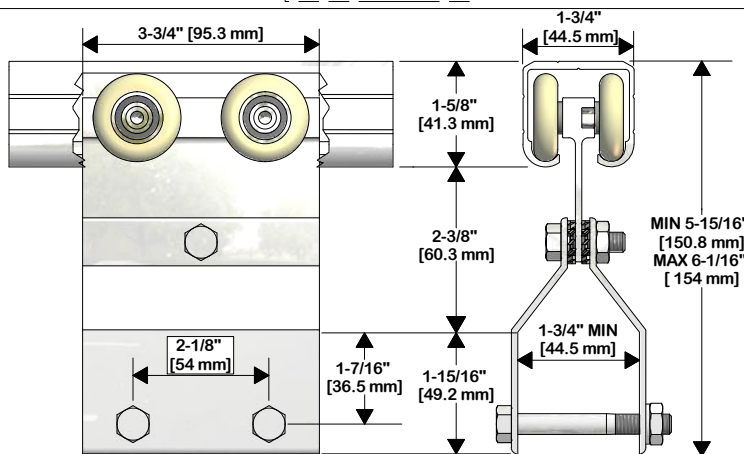

STEP 1

DETERMINE DOOR SIZE/HEADER HEIGHT BASED ON DIMENSIONS SHOWN IN DETAIL VIEWS AND CLEARANCE REQUIRED BELOW DOOR.

STEP 2

LOCATE AND DRILL 21/64"Ø HOLES FOR BOLTS USING THE DIMENSIONS SHOWN IN ILLUSTRATION. NOTE: IF USING CAS-2 DOOR STOP ADD 2" TO DIMENSION FROM EDGE OF DOOR.

STEP 3

PREPARE DOOR FOR INSTALLATION OF OPTIONAL PRODUCTS IF PURCHASED SUCH AS GUIDE CHANNELS, CUP PULLS, DOOR LOCKS, ETC. INDIVIDUAL INSTRUCTIONS ARE PROVIDED WITH THE RESPECTIVE PRODUCT.

STEP 4

PLACE HANGER ASSEMBLY ON DOOR AND SECURE CLAMPS TO DOOR WITH 5/16"-18 HEX BOLTS(2), 5/16" WASHERS(2), AND 5/16" HEX NUTS(2).

STEP 5

PLACE DOOR AND HANGERS INTO C-104 OR C-108 TRACK AND SECURE TO HEADER. ALTERNATE: IF TRACK ENDS ARE NOT ACCESSIBLE AFTER MOUNTING: AFTER PREPARING DOOR FOR HANGERS, INSTALL HANGERS IN TRACK AND MOUNT TRACK. RAISE DOOR INTO POSITION BELOW HANGERS & BOLT THROUGH PREDRILLED HOLES.

STEP 6

LOCK DOOR HEIGHT AND PLUMB WITH 1/2" WRENCH ON HEX NUT OF CENTER BOLT.

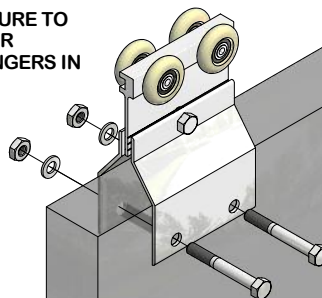
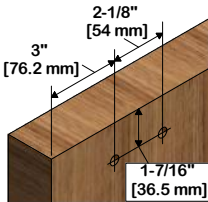
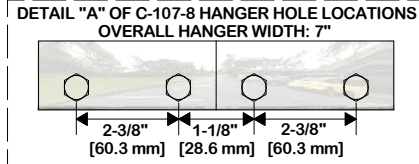

C-107-4 HANGER FOR C-104 OR C-108 TRACK INSTRUCTION SHEET

PARTS LIST

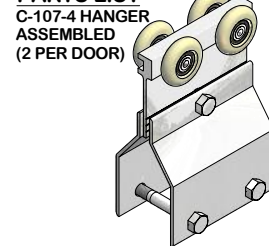

5/16"-18 X 2-1/2" HEX BOLT (2 PER HANGER)



5/16" PLAIN WASHER (2 PER HANGER)



5/16" HEX NUT (2 PER HANGER)



EXTRUDED ALUMINUM TRACK

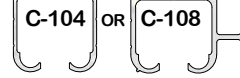

OR C-107-8 HANGER ASSEMBLED 7" WIDE (2 PER DOOR)

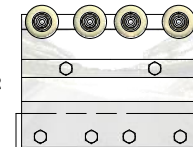

C-107-8 DETAIL "A"

SPECIFICATIONS:
-LOAD CAPACITY:
C-107-4 HANGERS:
350 LBS PER DOOR
C-107-8 HANGERS:
600 LBS PER DOOR

-HEAVY-DUTY PRECISION BALL BEARING WHEELS WITH NYLON TIRE.

-CLAMP-TYPE FACE MOUNTING DESIGN. ADJUSTABLE FOR DOOR THICKNESS OF 1-3/4" - 2-1/4".

-FOR BY-PASSING, BI-PARTING, POCKET, AND SURFACE MOUNT/BARN STYLE APPLICATIONS.

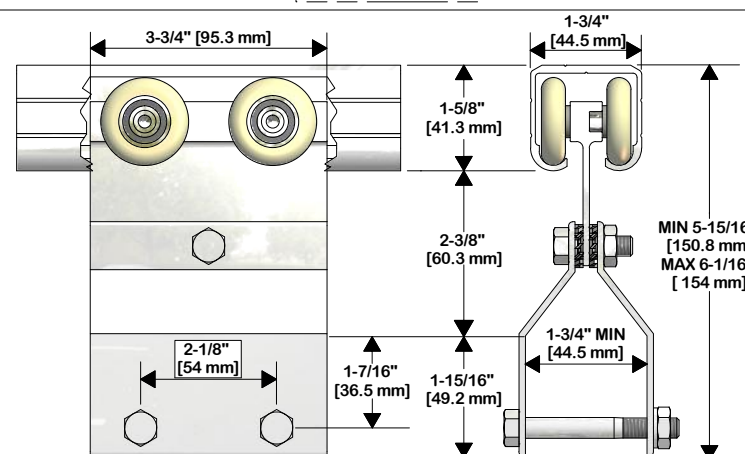

STEP 1

DETERMINE DOOR SIZE/HEADER HEIGHT BASED ON DIMENSIONS SHOWN IN DETAIL VIEWS AND CLEARANCE REQUIRED BELOW DOOR.

STEP 2

LOCATE AND DRILL 21/64"Ø HOLES FOR BOLTS USING THE DIMENSIONS SHOWN IN ILLUSTRATION. NOTE: IF USING CAS-2 DOOR STOP ADD 2" TO DIMENSION FROM EDGE OF DOOR.

STEP 3

PREPARE DOOR FOR INSTALLATION OF OPTIONAL PRODUCTS IF PURCHASED SUCH AS GUIDE CHANNELS, CUP PULLS, DOOR LOCKS, ETC. INDIVIDUAL INSTRUCTIONS ARE PROVIDED WITH THE RESPECTIVE PRODUCT.

STEP 4

PLACE HANGER ASSEMBLY ON DOOR AND SECURE CLAMPS TO DOOR WITH 5/16"-18 HEX BOLTS(2), 5/16" WASHERS(2), AND 5/16" HEX NUTS(2).

STEP 5

PLACE DOOR AND HANGERS INTO C-104 OR C-108 TRACK AND SECURE TO HEADER. ALTERNATE: IF TRACK ENDS ARE NOT ACCESSIBLE AFTER MOUNTING: AFTER PREPARING DOOR FOR HANGERS, INSTALL HANGERS IN TRACK AND MOUNT TRACK. RAISE DOOR INTO POSITION BELOW HANGERS & BOLT THROUGH PREDRILLED HOLES.

STEP 6

LOCK DOOR HEIGHT AND PLUMB WITH 1/2" WRENCH ON HEX NUT OF CENTER BOLT.

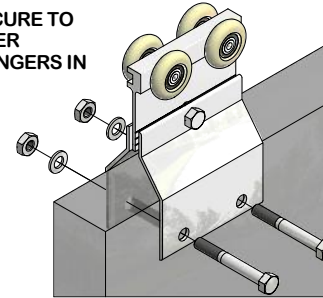
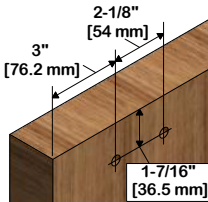
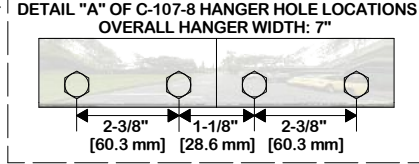

K.N. CROWDER MFG. INC.
1220 BURLOAK DRIVE
BURLINGTON, ONTARIO, CANADA, L7L 6B3
TELEPHONE: 905-315-9788 - FAX: 905-315-8090
TOLL FREE FAX: 1-800-567-0123

K.N. CROWDER INC.
210 EIGHTH STREET SOUTH
LEWISTON, NEW YORK, U.S.A. 14092
TELEPHONE: 1-716-754-8247
TOLL FREE FAX: 1-800-567-0123

WEBSITE: www.kncrowder.com -- E-MAIL: customerservice@kncrowder.com



K.N. CROWDER MFG. INC.
1220 BURLOAK DRIVE
BURLINGTON, ONTARIO, CANADA, L7L 6B3
TELEPHONE: 905-315-9788 - FAX: 905-315-8090
TOLL FREE FAX: 1-800-567-0123

K.N. CROWDER INC.
210 EIGHTH STREET SOUTH
LEWISTON, NEW YORK, U.S.A. 14092
TELEPHONE: 1-716-754-8247
TOLL FREE FAX: 1-800-567-0123

WEBSITE: www.kncrowder.com -- E-MAIL: customerservice@kncrowder.com