

C-2172 Passage Set

Installation Instructions

Specifications

Door Thickness: 1 3/8 in [34.9 mm] minimum

Not to scale

Included Components

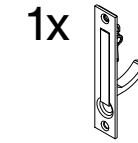

C-21
Edge Pull Body

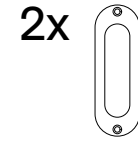

C-72
Flush Pull

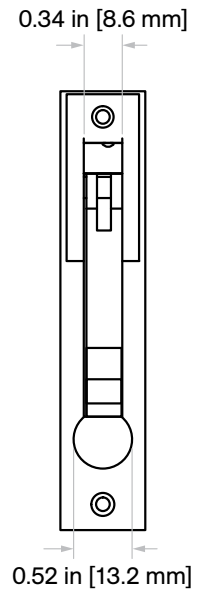
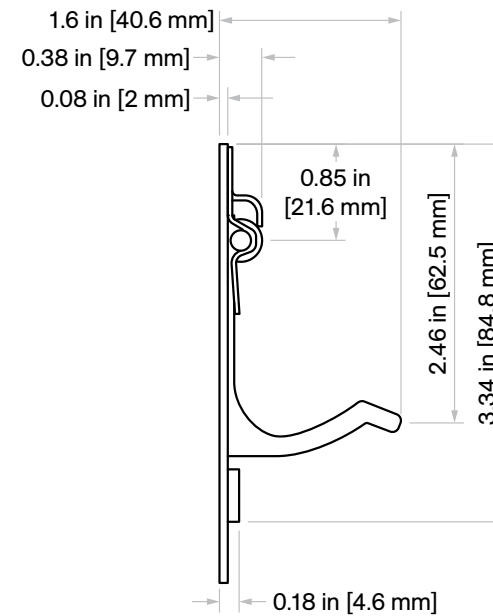
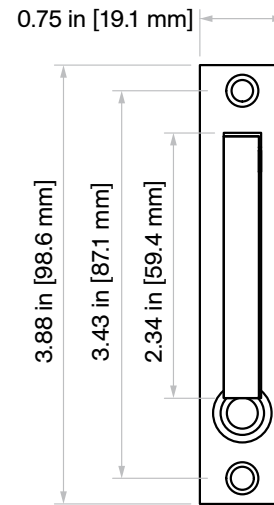
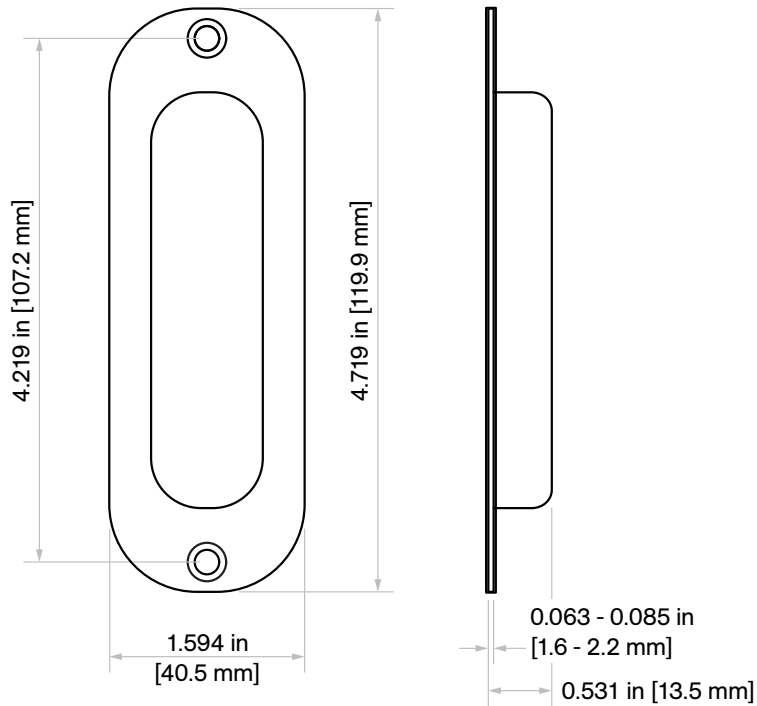

Door Prep Template

Horizontal and vertical spacing of the flush pulls is up to the end user. However, we do suggest to line up the backset with the other locks on your project.

For example: 2 in [50.8 mm], 2.5 in [63.5 mm], 2.75 in [69.8 mm], 5 in [127 mm], and 6 in [152.4 mm]

Responsibility

Door and frame manufacturers are responsible for providing adequate construction or reinforcement for proper installation of hardware shown.

C-72

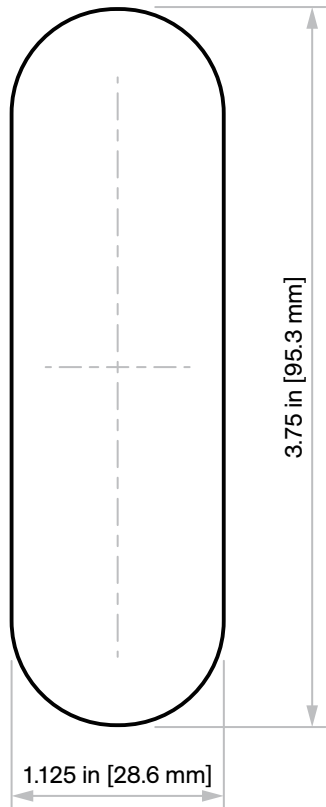

C-21

